

# Data Sheet for Precision Potentiometer

Oil filled multiturn wirewound Potentiometer

Series OF50



The potentiometers OF50 are filled with oil. The oil has a heat-dissipating function, cleans the resistance element of abrasion and protects it from moisture and aggressive substances.

- Optional tandem version
- Optional rear shaft
- On request with limit switch

Electrical Data	OF5003	OF5005	OF5010
Effective electrical angle of rotation 1.)	1080° ±5°	1800° ±5°	3600° ±5°
Total resistance 1.)	100 Ohm..200 kOhm		
Resistance tolerance	±5% (±3%, ±1%)		
Independent linearity (best straight line) 1.)	±0,3% (±0,1%), ±0,15% $R \leq 5k\Omega$		
Theoretical resolution 1.)	Depends on resistance value (see table below)		
Backlash (Hysteresis) 1.)	≤ 0,5°		
Rotational noise (ENR) 1.) (Method C)	100 Ohm		
Max. / recommended wiper current 1.)	35 mA / 2 µA		
Power rating @ 40°C (0W @ 60°C)	5 W		
Insulation Voltage 1.)	1000 VAC, 1min		
Insulation Resistance 1.)	100 MOhm @ 1000 VDC		

Mechanical Data, Environmental Conditions, Miscellaneous	OF5003	OF5005	OF5010
Mechanical angle of rotation	1080° +10° with stop	1800° +10° with stop	3600° +10° with stop
Lifetime (90% el. eff. angle half sine) 2.)	0,5 Mio. rotations	1 Mio. rotations	2 Mio. rotations
Max. operational speed	40 rev. / min.		
Bearing	Sleeve bearing		
Operational torque @ ambient temperature 1.) 2.)	30 Nmm		
End stop torque 1.) 2.)	90 Ncm		
Operating temperature range	-30..+60°C		
Storage temperature range	-30..+60°C		
Protection grade (IEC 60529)	IP65		
Vibration (IEC 68-2-6, Test Fc)	15g 10..2000Hz x 12h		
Shock (IEC 68-2-27, Test Ea)	49g @ 11 ms x 18		
Housing diameter	62 mm		
Housing depth	75 mm		
Shaft diameter	6 mm (optional 6,35 mm)		
Shaft type	Solid shaft		

# Data Sheet for Precision Potentiometer

Oil filled multiturn wirewound Potentiometer

Series OF50

Mechanical Data, Environmental Conditions, Miscellaneous	OF5003	OF5005	OF5010
Max. radial load		≤1 N	
Max. axial load		≤1 N	
Connection type		Soldering lugs	
Connection position		Axial	
Sensor mounting		Bushing	
Mass		290 g	
Fastening parts included in delivery		Nut, toothed washer	
Fastening torque mounting nut		150 Ncm	
Material shaft		Stainless steel	
Material housing		Metal	

1.) According IEC 60393

2.) Determined by climatic conditions according to IEC 68-1, para. 5.3.1 without load collectives

Please note: Max. permissible supply voltage <75 VDC respectively <50 VAC in addition the max. power rating must be observed

Number of wire turns / resolution											
Resistance value Ohm	100	200	500	1k	2k	5k	10k	20k	50k	100k	200k
Number of wire turns 3	N/A	N/A	N/A	N/A	N/A	N/A	N/A	N/A	N/A	N/A	N/A
Number of wire turns 5	N/A	N/A	N/A	N/A	N/A	N/A	N/A	N/A	N/A	N/A	N/A
Number of wire turns 10	2500	3180	4350	5400	6850	6600	8550	10850	14900	18850	24390

Resolution in degree E.g. R5k 10-turn =  $3600^\circ / 6600 = 0,545^\circ$  per winding resistive wire

# Data Sheet for Precision Potentiometer

Oil filled multiturn wirewound Potentiometer

Series OF50

## Order code

Description		Selection: standard=black/bold, possible options=grey/cursive						
<b>Series</b>	<b>OF50</b>							
<b>Revolution with stop:</b>								
Option 3 turn		03						
Option 5 turn		05						
<b>10 turn</b>		<b>10</b>						
<b>Resistance value / Option Tandem:</b>				<i>Tandem</i>				
Option 100 Ohm			R100	/100				
Option 200 Ohm			R200	/200				
Option 500 Ohm			R500	/500				
<b>1 kOhm</b>			<b>R1k</b>	/1k				
Option 2 kOhm			R2k	/2k				
<b>5 kOhm</b>			<b>R5k</b>	/5K				
<b>10 kOhm</b>			<b>R10k</b>	/10K				
Option 20 kOhm			R20k	/20K				
Option 50 kOhm			R50k	/50k				
Option 100 kOhm			R100k	/100k				
Option 200 kOhm			R200k	/200k				
Option rear shaft:								
Standard Ø6,00 x 28 mm					RA			
Shaft length in mm					RAxx,xx			
Shaft diameter in mm (≤6 mm)					RADMx,xx			
<b>Resistance tolerance:</b>								
<b>±5%</b>						<b>W5%</b>		
Option ±3%						W3%		
Option ±1%						W1%		
<b>Independent linearity:</b>								
<b>±0,3%</b>						<b>L0,3%</b>		
Option ±0,15% R ≤ 5kOhm						L0,15%		
Option ±0,1% R > 5kOhm						L0,1%		
<b>Front shaft:</b>								
<b>Standard Ø6,00 x 28 mm</b>							-	
Option Ø6,35 mm							DM6,35	
Option shaft length in mm							Ax,xx	
Option shaft diameter in mm (≤6,35 mm)							DMx,xx	
Option screwdriver slot:								B

## For higher quantities or on-going demand, additional options are available as described below on request

For Example: Limit switch, multi ganged potentiometers, special electrical and mechanical angles of rotation, and special resistance and linearity tolerances. Furthermore we can mount gear wheels or attach cable assemblies with or without connectors and much more.

# Data Sheet for Precision Potentiometer



Oil filled multiturn wirewound Potentiometer

Series OF50

## Drawing

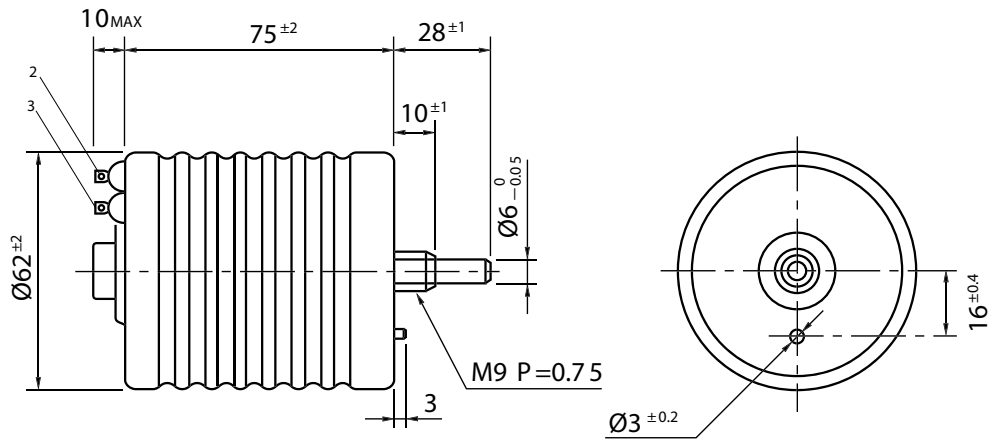
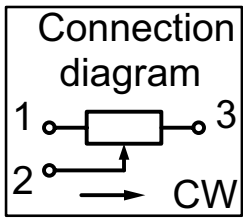

Dimensions in mm

**On Request: Special machining on shaft**

Slot

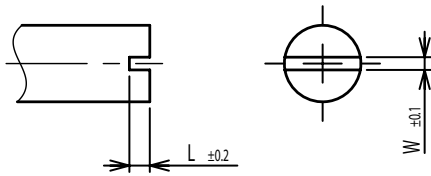

Groove

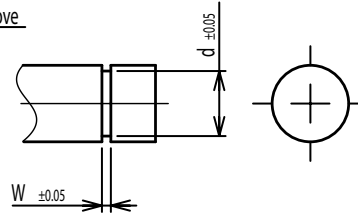

Flat

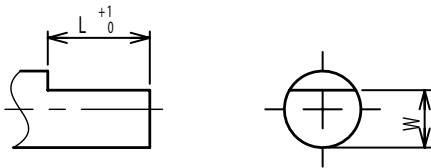

Round top

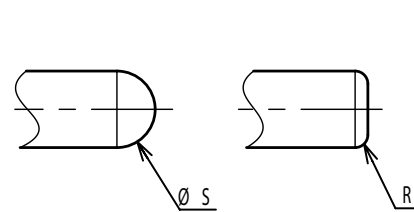

Double side flat

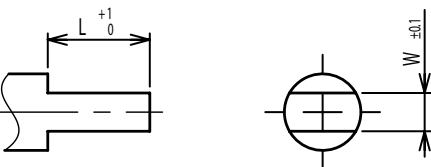

Counterbore hole

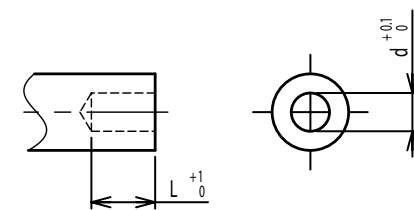

Step

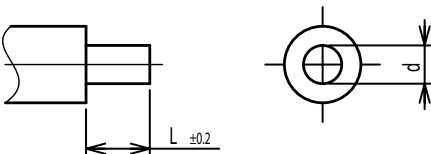

Counterbore screw hole

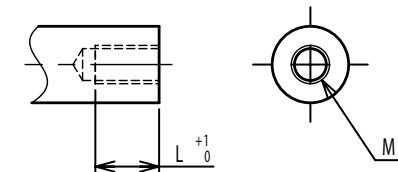

Screw Thread

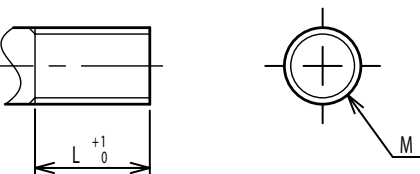

Pin hole

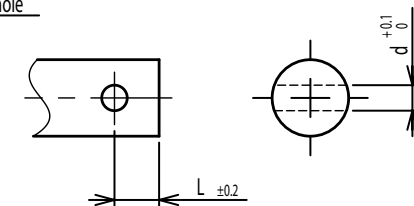

Knurled(Parallel)

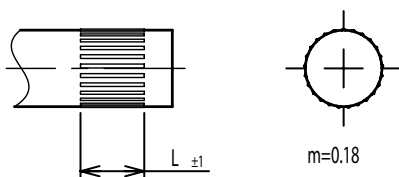

Screw thread inside hole

